

Secondary Glazing Horizontal Sliders 2 to 6 panel configurations

Outerframe 307/308 - Odd Leg - Reverse Fix

Typical Elevation

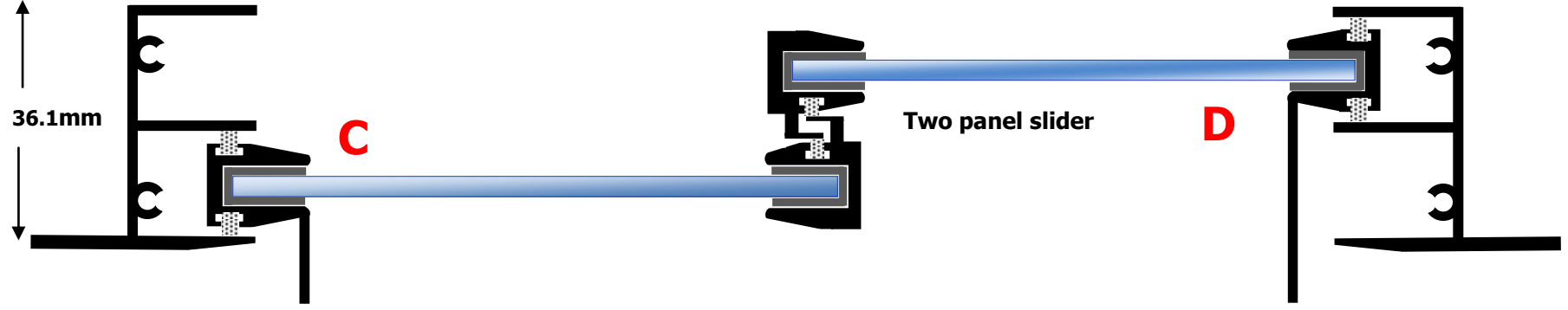
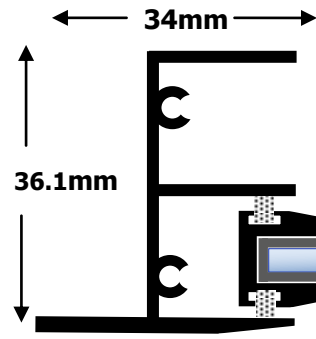
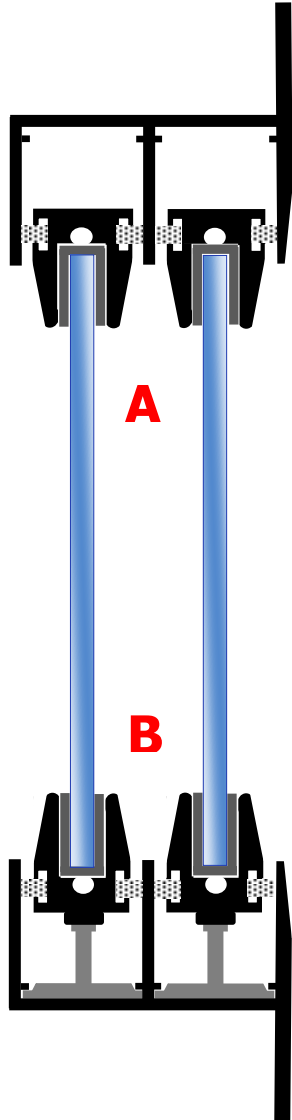
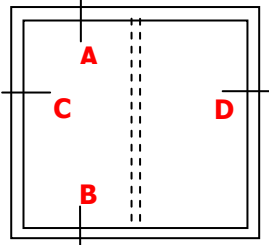

Two panel slider



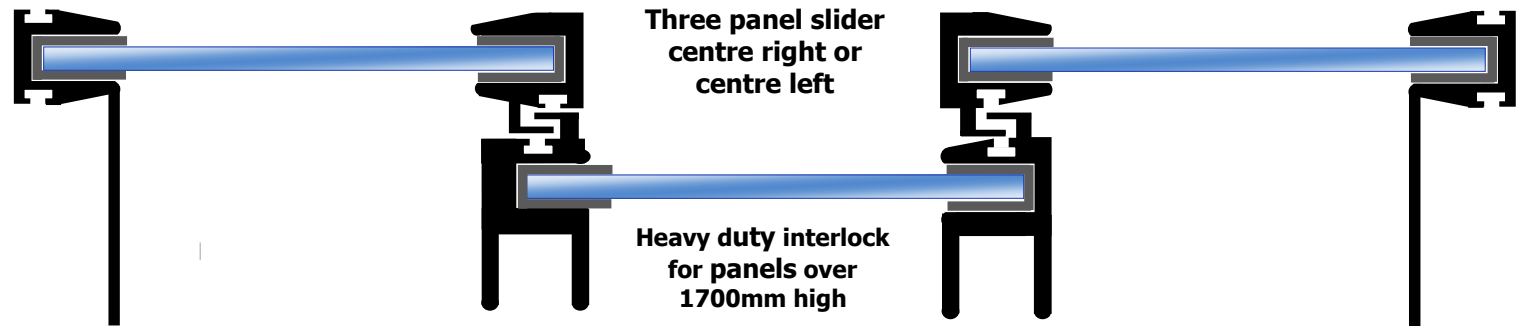

Three panel slider centre fixed

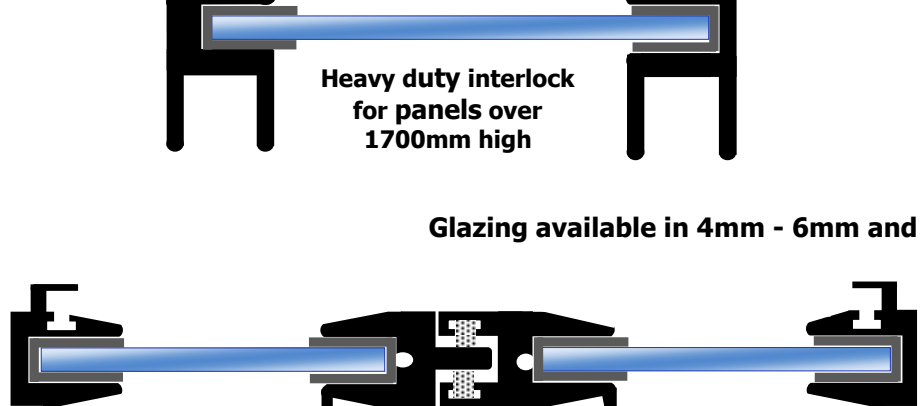

Three panel slider centre right or centre left



Heavy duty interlock for panels over 1700mm high

Panels slide on nylon skids  or steel rollers 

Glazing available in 4mm - 6mm and 6.4mm laminate glass

Four panel slider Bi-Part

Do not scale 1 to 1